



**A global standard 3D coordinate measuring machine featuring high accuracy, high speed and high environmental resistance and supporting a variety of probe systems**

**XYZAX AXCEL**

In every industry, there are ever diversifying needs for measuring machines - high-accuracy measurement of parts manufactured with increasingly high accuracy, reduction in measurement time during the inspection, improvement in throughput, measurement of parts having complicated shapes, etc.

XYZAX AXCEL achieves higher accuracy, higher drive speed and a wider accuracy guarantee temperature range.

What's more, it allows various types of probe system to be selected as appropriate for the intended purpose, making it possible to deal with any kind of application.

XYZAX AXCEL - a machine that we have positioned as a new global standard - meets the increasingly diverse needs.





## Class highest level accuracy



Maximum permissible error of length measurement : E0, MPE (μm)

Up to the size of 10/15/8

**1.8 + 3L / 1000**

Featuring a newly developed highly rigid bridge and a new structure in which the Y-axis guide is supported by air pads from four directions (top, bottom, left and right), XYZAX AXCEL offers best-in-class accuracy.

## Stunning speed realized by a newly developed driving mechanism

Drive speed **700 mm/sec max.**



Up **64%** max. compared to our previous models

Acceleration **2300 mm/sec<sup>2</sup> max.**



Up **35%** max. compared to our previous models

The driver of each axis uses a newly developed driving mechanism to enable high-speed and stable drive.

A change from the former belt-driven method to the newly developed drive system dramatically improves maneuverability.

This newly developed driving mechanism increases the drive speed by 64% and acceleration by 35% (compared to our previous models).

The new mechanism reduces the total time required for measurement, significantly increasing the measurement efficiency.

## Wide temperature range for guarantee accuracy 15 to 30°C\*

A newly designed cover is used that prevents the X-axis guide and Y-axis carriage from being affected directly by temperature changes. Furthermore, by adopting a structure designed to suppress the deformation of the stone worktable due to temperature changes, XYZAX AXCEL minimizes the impact of temperature changes. It supports a substantially wider accuracy guarantee temperature range of 15 - 30°C\* while maintaining high accuracy.

This temperature range for guarantee accuracy helps you save the cost for temperature control in the measuring room.

\*RDS type standard. PH type is optional

# Elemental technologies to enable higher accuracy

## Newly developed highly rigid bridge



### Y direction

**3.8** times as rigid as previous models

### Torsion direction

**1.5** times as rigid as previous models

The rigidity of the bridge, an essential part of a 3D coordinate measuring machine, has a great impact on the accuracy of measurement.

XYZAX AXCEL uses a newly developed highly rigid bridge. With its X-axis guide structure entirely redesigned, this machine now provides substantially higher rigidity both in the Y direction and torsion direction.

This newly developed highly rigid bridge is the biggest factor in achieving high accuracy for XYZAX AXCEL.

## Y-axis supported by air pads from four directions **patented**

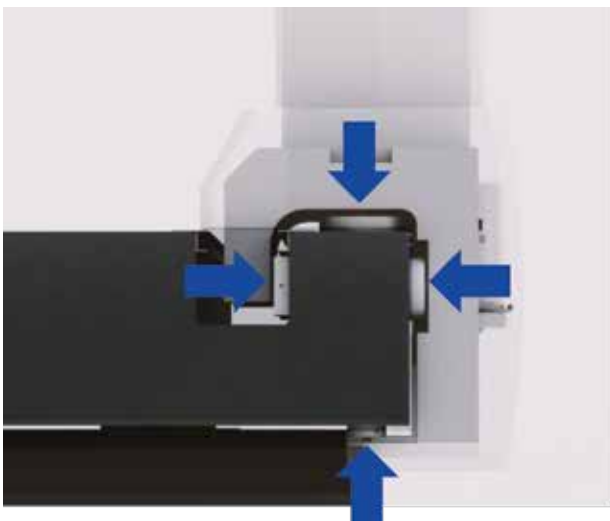

Reduction in runout in the pitching direction

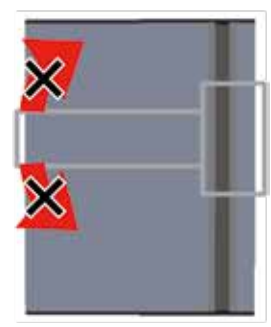

Reduction in runout in the yawing direction

In addition to the highly rigid bridge, XYZAX AXCEL adopts a newly developed support structure in which the Y-axis guide is supported by air pads from four directions (top, bottom, left and right) (patented).

This structure reduces the runout that occurs in the pitching direction and yawing direction when the bridge is moved in the Y direction.

Reducing the vibration at the tip of the probe makes the machine even more accurate.

# Elemental technologies to expand the temperature range for accuracy guarantee

## X-axis guide cover\* / Y-axis carriage cover



X-axis guide cover



Y-axis carriage cover



New developed covers are adopted for the X-axis guide and Y-axis carriage. Protecting the guide and carriage with covers reduces the impact of temperature changes, which enables to expanding the temperature range for guarantee accuracy of XYZAX AXCEL. The X-axis guide cover also prevents contaminants from attaching to the X-axis guide.

\*Standard feature for the RDS type. For the PH type, the cover is a standard feature for 10/10/6 and larger sizes and an option for other sizes.

## Worktable structure to suppress the impact of temperature changes patented

Y-axis groove structure that prevents heat generated by the motor or other parts from entering the measurement area of the worktable



Special insulating material that reduces heat coming in and out of the front and rear of the worktable to suppress the generation of a temperature gradient

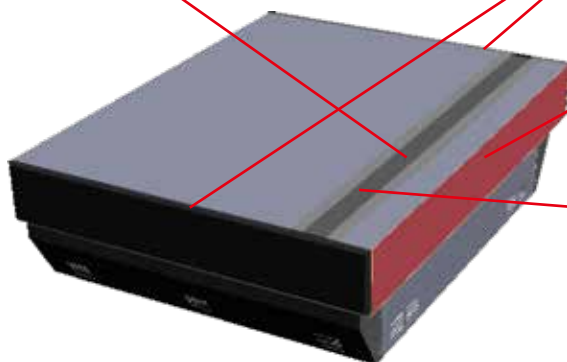

Uncovered Y-axis guide to dissipate heat



Y-axis shutter structure that suppresses the inflow of ambient air as well as prevents contaminants from attaching to the scale inside

Since the stone worktable is low in thermal conductivity, heat is not readily transferred to the inside. If the ambient temperature changes, a temperature gradient persists for a long time until the temperature inside the worktable becomes uniform. Such a temperature gradient deforms the worktable, which causes a decrease in straightness of the worktable surface, resulting in lower measurement accuracy. XYZAX AXCEL solves these problems by adopting a Y-axis groove structure, installing insulating material at the front and rear ends of the worktable and introducing an uncovered Y-axis guide structure designed to dissipate heat.



## Features and options for enhanced performance

### Air Saver function (standard feature) effective for power saving and running cost cutting

XYZAX AXCEL features the Air Saver function that automatically stops the supply of compressed air when the machine is idling, as automobiles stop idling. This reduces the unnecessary consumption of air, contributing to power saving and running cost cutting.

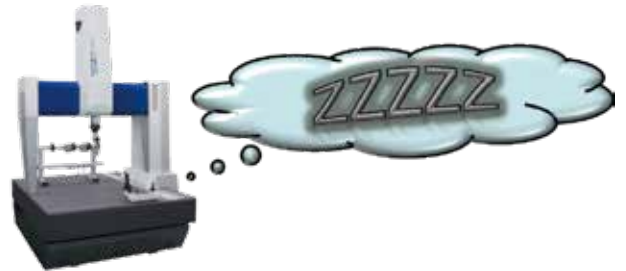

### Air anti-vibration unit to reduce the transmission of vibration from the floor (standard feature for Z800 and larger sizes\*)

An air anti-vibration unit can be mounted in XYZAX AXCEL. It reduces the transmission of vibration from the floor and suppresses its impact. Since mounting the air anti-vibration unit does not change the dimensions of the machine, you can use it without worrying about the installation space.



\*Option for Z600 and smaller sizes. A base cover is attached for mounting the air anti-vibration table.

Anti-vibration unit (left) and base cover attached to the anti-vibration unit (right)

### The special stand specification to which the height from a floor to the surface of the table is changed (option\*)

Although the height from a floor to the surface of the table of XYZAX AXCEL is 600 mm (Z600 size) or 630 mm (Z800 and Z1000 size), it is able to change the height as the special stand specification (example: 800 mm specification with which it might be easy to operate even while standing up).

\*This option is a factory option.

Height from floor to the surface of the table  
800 mm Specification

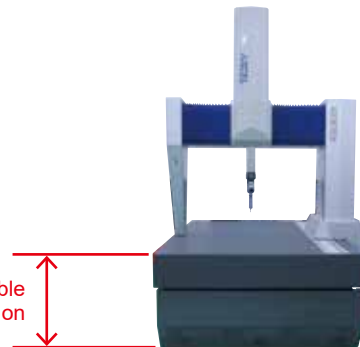

### Covers for both Y axis guides (option\*)

Covering both the right and left Y axis guides can protect the guide surfaces, preventing dust adhesion and occurrence of scratches caused by contact with workpieces and jigs. This option is effective when using XYZAX AXCEL outside the measurement room, such as inside the workshop, as it enhances the environmental resistance of the machine, combined with the wide range of accuracy guarantee temperature.

\*This option is a factory option.



### LED light function (option)

An LED light to illuminate the worktable can be mounted as an option below the X-axis guide. The light brightly illuminates the area around your hands and minute parts of the workpiece, leading to enhanced operability.

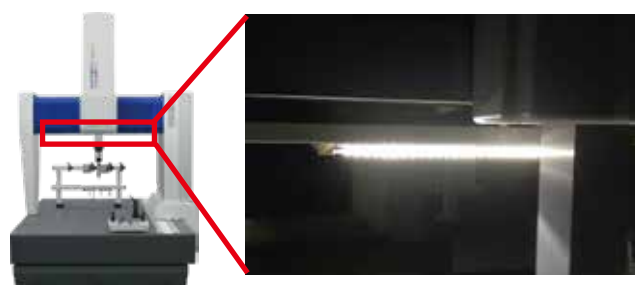



# XYZAX AXCEL RDS

**Non-contact measurement also supported  
High-accuracy scanning measurement model of  
the AXCEL series**

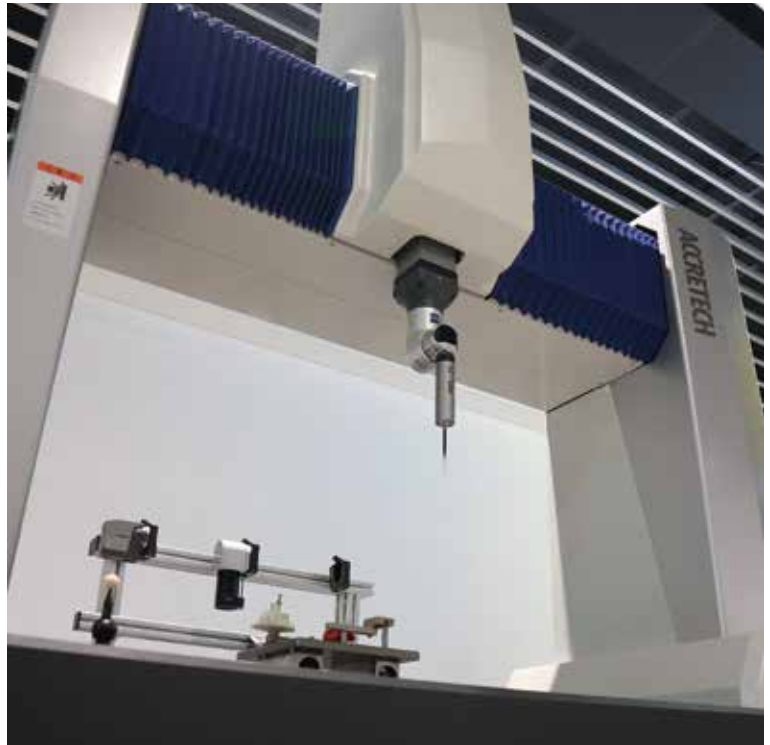

**Probe head capable of handling all kinds of workpiece  
RDS-C5 (standard feature for XYZAX AXCEL RDS)**



RDS-C5 is a motorized indexing probe head that is provided as a standard feature for XYZAX AXCEL RDS.

It can be rotated  $\pm 180^\circ$  at a pitch of  $5^\circ$  in both horizontal and vertical directions and allows positioning at 5,184 points\*. Since the probe can be moved smoothly in fine steps, you can measure even those workpieces having complex shapes.

\*Safety restrictions may occur at the vertical rotation angle depending on a combining probe systems

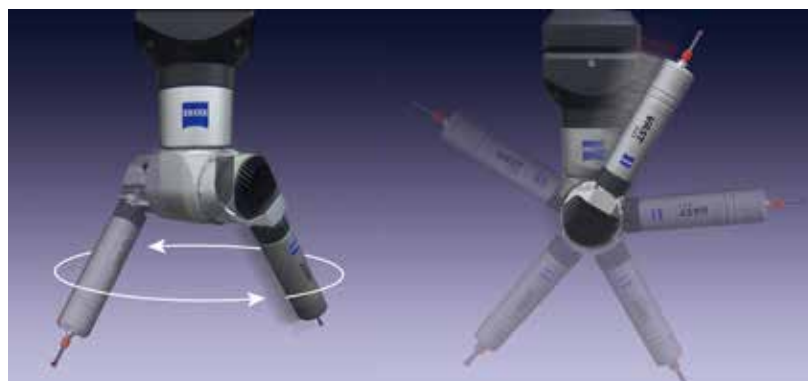

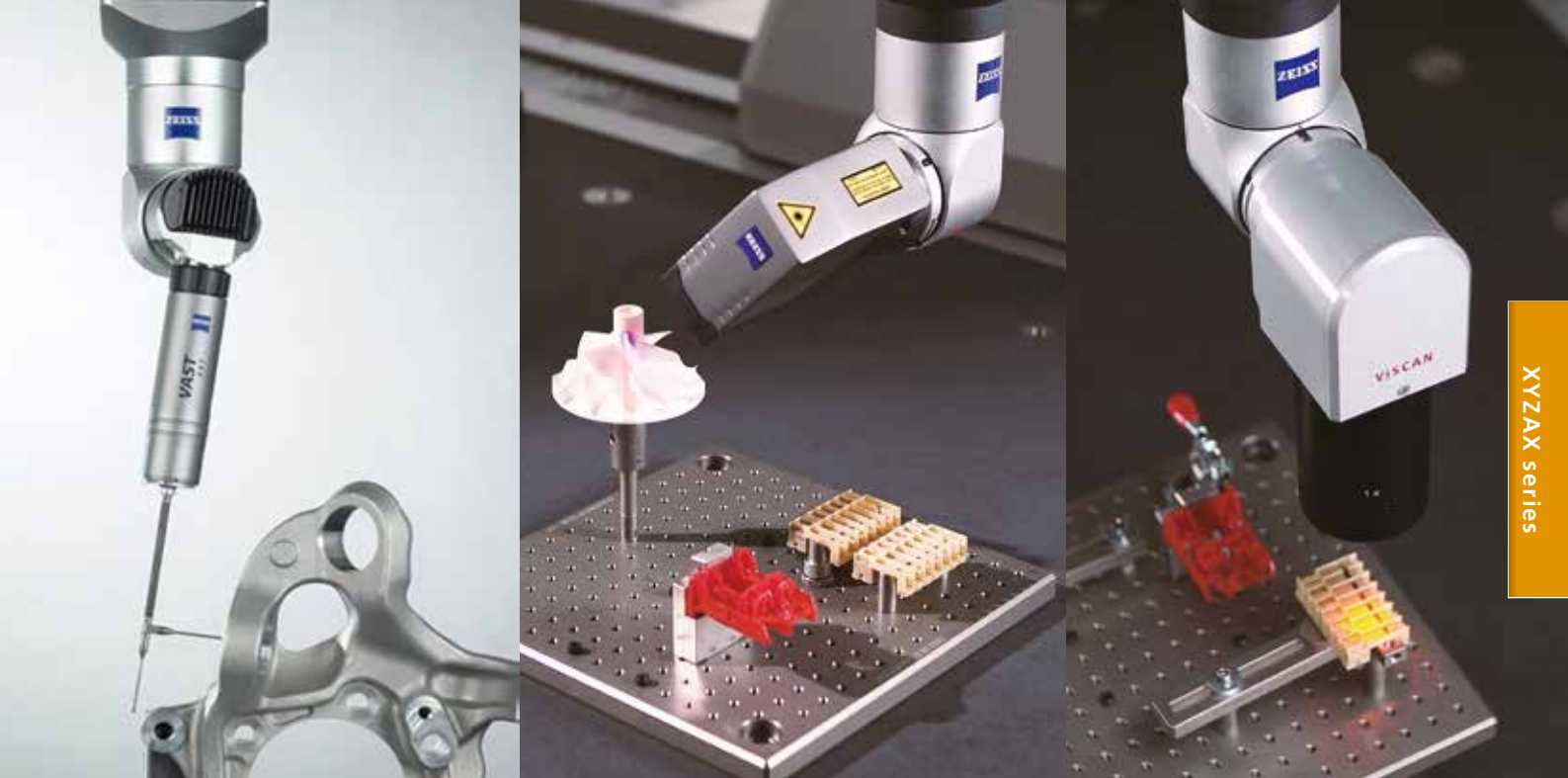

## Attach various types of probe as needed

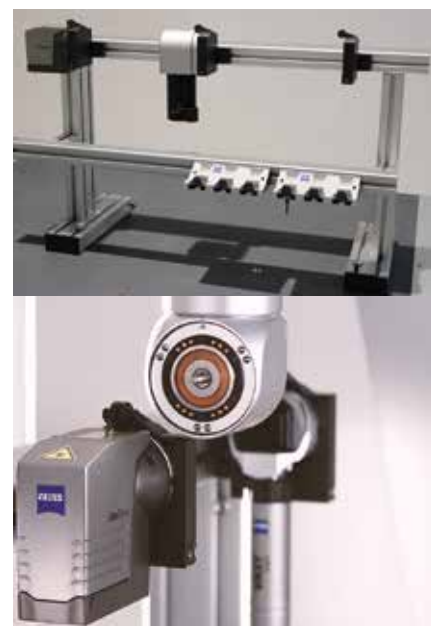
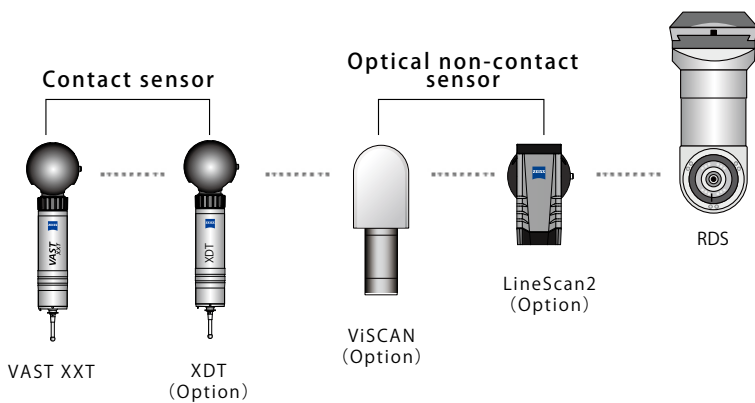

The probe can be changed automatically.  
(The rack, replacement magazine, probe socket, etc. are options)

To the RDS-C5 probe head, you can attach various types of probe as needed.  
In addition to the VAST XXT TL3 scanning probe provided as a standard feature, you can attach other optional probes, such as the ViSCAN optical probe that performs non-contact image measurement from different angles and the LineScan2 laser probe that enables wide-range, high-speed surface measurement. This allows the probe head to meet a vast range of measurement needs.

## RDS-CAA function that dramatically reduces the calibration time



An ordinary motorized indexing probe needs to be calibrated at its every measurement position. With RDS-C5 that features the RDS-CAA function, by contrast, all you have to do is have the probe calibrated automatically just at 12 specified positions, and you can use the probe at all of the 5,184 positions without calibration.  
This RDS-CAA function can significantly reduce the time required for calibration.



## Probe for scanning measurement VAST XXT (TL3: Standard, TL4: Option)



You can choose between the standard TL3 type and the optional TL4 type whose maximum axial direction length is 250 mm.

VAST XXT is a passive scanning probe that you attach to the RDS head. With an ordinary passive scanning probe, the deflection correction error tends to become uncertain because the measuring force greatly changes within the movable range. VAST XXT, by contrast, keeps the measuring force very low (0.01 to 0.13 N\*) and the amount of change small. The low measuring force makes it possible to use a stylus whose minimum ball diameter is 0.3 mm. Also, since the probe deflection range is wide ( $\pm 3$  mm), the impact of collision can be minimized.

\*The measuring force varies depending on the length and angle of the stylus.



## Probe for point measurement XDT (option)

XDT is a probe for point measurement that you attach to the RDS head. Like VAST XXT of the TL3 type, this probe supports the wide probe deflection range of  $\pm 3$  mm, and you can attach a stylus whose maximum axial direction length is 150 mm and whose maximum horizontal direction length is 65 mm. In addition to the stylus, joints and extensions, the adaptor plate for automatic stylus replacement can be shared with VAST XXT TL3.

|                         | Measurement method       | Axial direction stylus length (mm) | Horizontal direction stylus length (mm) | Maximum stylus weight (g) | Minimum stylus ball diameter (mm) |
|-------------------------|--------------------------|------------------------------------|---|---------------------------|-----------------------------------|
| VAST XXT TL3 (standard) | Point / passive scanning | 30 - 150                           | Max. 65                                 | Max. 15                   | φ 0.3                             |
| VAST XXT TL4 (option)   | Point / passive scanning | 125 - 250                          | Max. 40                                 | Max. 10                   |                                   |
| XDT (option)            | Point                    | 30 - 150                           | Max. 65                                 | Max. 15                   |                                   |

## Non-contact type image probe ViSCAN (option)



ViSCAN is a non-contact optical probe that you attach to the RDS head. Using this probe in combination with the RDS head, you can perform image measurement from many different angles. Like a contact-type probe, it supports both joystick manual measurement and automatic CNC measurement. Also, in addition to point measurement at an arbitrary position through target monitoring, as done with a centering microscope, scanning measurement is possible.

The probe is ideal for workpieces that cannot be measured with a contact-type probe, such as extremely small workpieces that a stylus cannot touch, workpieces with small holes or grooves and soft or thin workpieces that can easily be deformed.

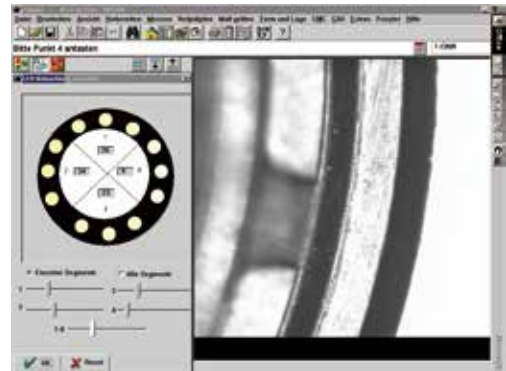

Manual setting of split light and brightness. These settings are also applied to automatic measurement.

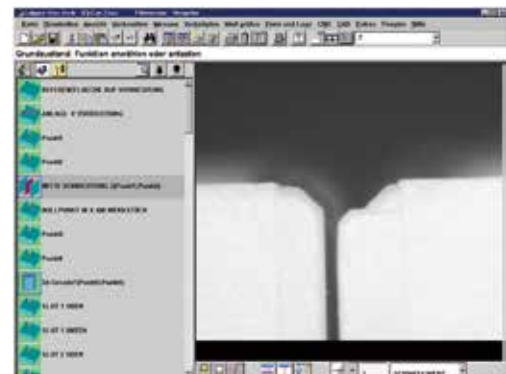

Measurement of a groove width of 0.16 mm

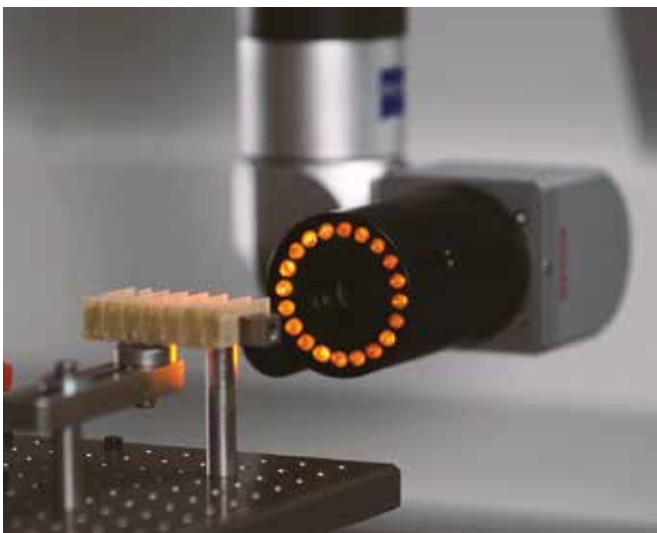
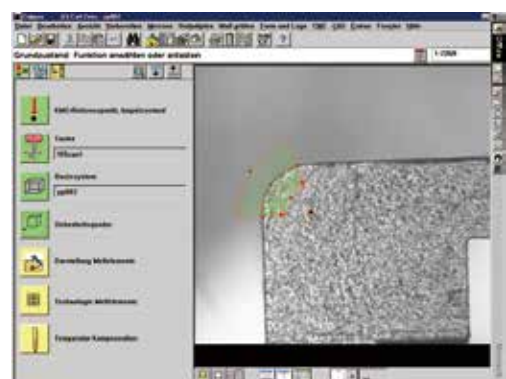

Image measurement possible from many different angles



Multipoint measurement of a circle segment

## Non-contact line laser probe LineScan2 system



LineScan2 is a laser probe to be mounted on the RDS head. It acquires numerous measurement points by oscillating semiconductor lasers and receiving light reflection from the workpiece. It is useful to obtain a large quantity of point cloud data for reverse engineering or significantly reduce surface measurement lead time. LineScan2 offers four models with different measurement ranges and accuracies, allowing non-contact measurement for various types of parts.

| Item   | Model | LineScan 2-8       | LineScan 2-25      | LineScan 2-50      | LineScan 2-100     |
|--|-------|--------------------|--------------------|--------------------|--------------------|
| Z measuring range (mm)                                 |       | 8                  | 25                 | 50                 | 100                |
| Working distance (mm)                                  |       | 32                 | 63                 | 94                 | 220                |
| Max.line width (at center of Z measurement range) (mm) |       | 10                 | 25                 | 50                 | 80                 |
| Max.sampling rate                                      |       | 700,000 points/sec | 700,000 points/sec | 256,000 points/sec | 700,000 points/sec |
| Probing error $MPE_{PF(OT)}$ ( $\mu m$ )               |       | 3.3                | 12                 | 20                 | 50                 |
| Dispersion on sphere ( $1\sigma$ ) ( $\mu m$ )         |       | 0.9                | 4                  | 5                  | 12                 |

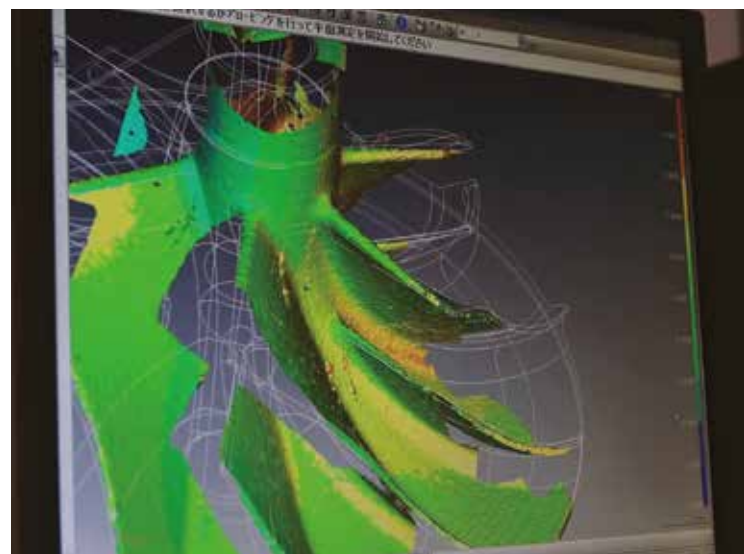
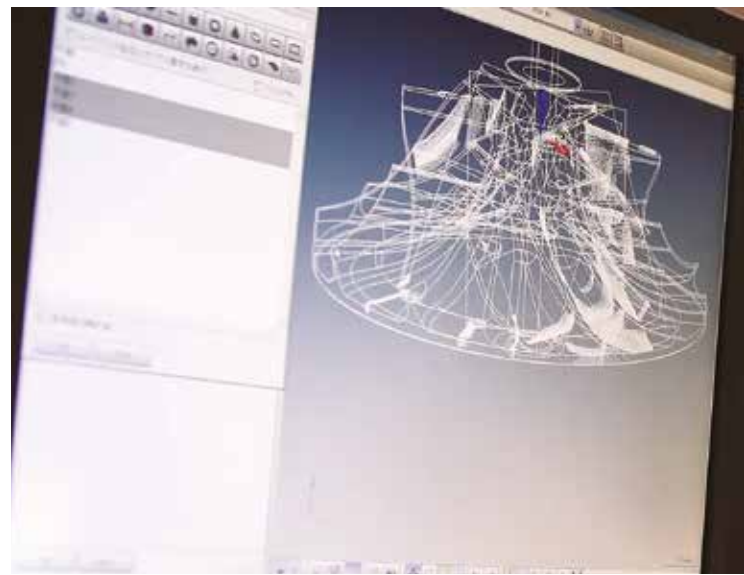
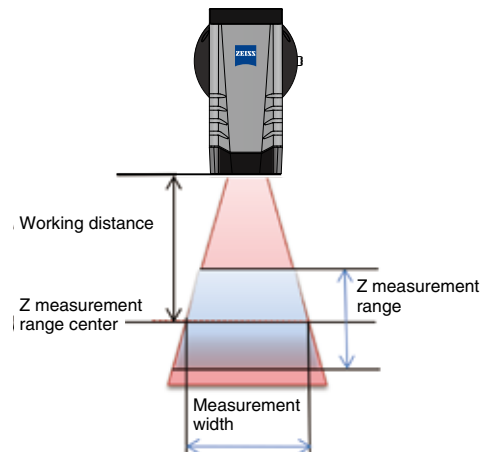



**New model in LineScan2 system with greatly improved accuracy. Ideal for high-speed and high-accuracy measurement of glossy surfaces such as polished mold surfaces.**

## LineScan2-8

A high accuracy model using blue semiconductor laser is newly introduced in the LineScan2 system. In addition to high sampling rates, a feature of LineScan2, the new model allows you to conduct high-speed and high-accuracy measurement of gloss surfaces such as polished mold surfaces, which is usually difficult to perform, with enhanced adaptability to such surfaces.



XYZAX series

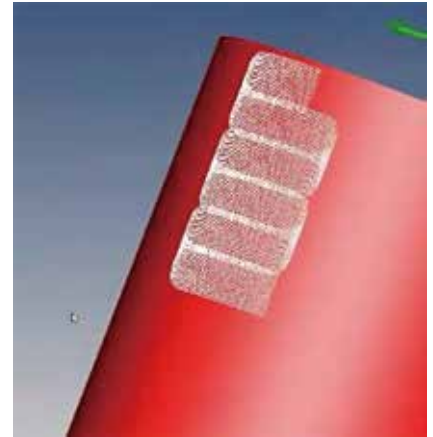
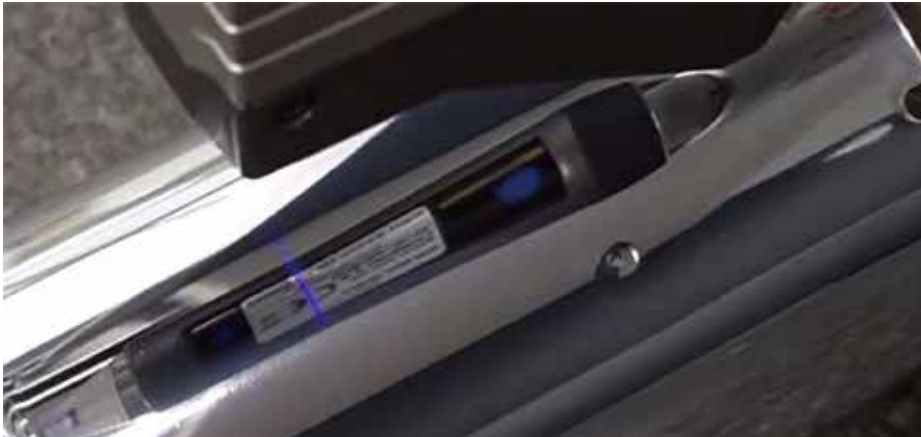

Measurement example of a specular finished surface with LineScan2-8

**In combination with LineScan2, reverse engineering and injection molding tool correction is strongly supported.**

## ZRE (ZEISS Reverse Engineering)

ZRE is a software that creates and corrects 3D CAD models based on the measurement results of parts. It can intuitively conduct reverse engineering and has an innovative, efficient and quantitative injection molding tool correction function.

- **Intuitive reverse engineering without requiring any expertise**



Automated segmentation of point cloud data



Easy reconstruct of a surface by pasting a shape on the segmented point clouds



Surface connection to create a 3D CAD model

- **“Tool correction” (optional) innovative and quantitative correction CAD models of injection molding tools**

Classical method of tool correction is performed by workers using intuition based on measurement data of an actual injection molded part. This new method transfers deviations between the 3D CAD model and actual data of the part and quantifies the amount of tool correction. Thus, the trial-and-error process of measuring a part, correcting the CAD model of the tool, remanufacturing and measuring the part, and recorrecting the CAD model of the tool is minimized. Tool correction can be performed efficiently without requiring experienced workers.

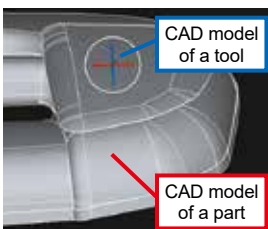

CAD models of the tool and part

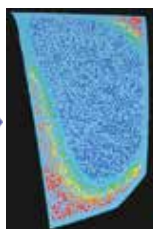

Deviations between the CAD model and measurement data of the part

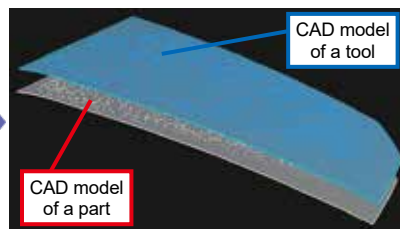

Transferring the deviations of the part to the CAD model of the tool

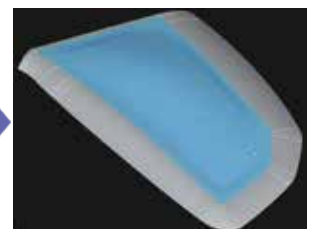

Corrected CAD model of the tool

# Specifications

| Model   |   |  |                              | XYZAX AXCEL RDS  |       |       |        |        |         |         |         |         |         |         |
|---|---|--|------------------------------|--|-------|-------|--------|--------|---------|---------|---------|---------|---------|---------|
|   |   |  |                              | 7/5/5  | 7/7/5 | 9/6/6 | 9/10/6 | 9/15/6 | 10/10/6 | 10/12/6 | 10/15/6 | 10/10/8 | 10/12/8 | 10/15/8 |
| Measuring Range   | X-axis (mm)   | 650  |                              | 850  |       |       | 1000   |        |         | 1000    |         |         |         |         |
|   | Y-axis (mm)   | 500  | 700                          | 600  | 1000  | 1500  | 1000   | 1200   | 1500    | 1000    | 1200    | 1500    |         |         |
|   | Z-axis (mm)   | 480  |                              | 600  |       |       | 800    |        |         | 800     |         |         |         |         |
| Measuring length scale                                  |   |  |                              | Linear scale   |       |       |        |        |         |         |         |         |         |         |
| Minimum display value (μm)                              |   |  |                              | 0.01   |       |       |        |        |         |         |         |         |         |         |
| Measurement accuracy <sup>1</sup>                       | RDS-C5 +VAST +XT                                      | Maximum permissible error of length measurement:<br>E <sub>0</sub> , MPE<br>E <sub>150</sub> , MPE | Temperature condition A (μm) | 1.8 + 3L/1000<br>2.3 + 3L/1000   |       |       |        |        |         |         |         |         |         |         |
|   |   |  | Temperature condition C (μm) | 1.8 + 4L/1000<br>2.3 + 4L/1000   |       |       |        |        |         |         |         |         |         |         |
|   |   |  | Temperature condition E (μm) | 1.8 + 5L/1000<br>2.3 + 5L/1000   |       |       |        |        |         |         |         |         |         |         |
|   |   | Maximum permissible of the repeatability range: R <sub>0</sub> , MPL (μm)                          | 1.3                          |  |       |       |        |        |         |         |         |         |         |         |
|   |   | Maximum permissible single-stylus form error: P <sub>FTU</sub> , MPE (μm)                          | 1.8                          |  |       |       |        |        |         |         |         |         |         |         |
|   |   | Maximum permissible scanning probing error: MPE <sub>THP</sub> (μm)                                | 2.9<br>(T = 75 s)            |  |       |       |        |        |         |         |         |         |         |         |
| Guidance system for each axis                           |   |  |                              | Air bearings   |       |       |        |        |         |         |         |         |         |         |
| Table   | Material  |  |                              | Gabbro   |       |       |        |        |         |         |         |         |         |         |
|   | Usable width (X) (mm)                                 | 950  |                              | 1050   |       |       | 1200   |        |         | 1270    |         |         |         |         |
|   | Usable depth (Y) (mm)                                 | 1400   | 1600                         | 1500   | 1900  | 2400  | 1900   | 2100   | 2400    | 2000    | 2200    | 2500    |         |         |
|   | Height from floor (mm)                                | 600  |                              | 600  |       |       | 630    |        |         | 630     |         |         |         |         |
|   | Flatness  |  |                              | JIS Class 1  |       |       |        |        |         |         |         |         |         |         |
|   | Clamping screw for workpiece                          |  |                              | M10 threaded hole  |       |       |        |        |         |         |         |         |         |         |
| Workpiece   | Max. height (mm)                                      | 670  |                              | 790  |       |       | 1000   |        |         | 1000    |         |         |         |         |
|   | Max. weight (kg)                                      | 600  | 800                          | 800  | 1000  | 1500  | 1000   | 1200   | 1500    | 1000    | 1200    | 1500    |         |         |
| Drive speed   | Max. acceleration/deceleration (mm/sec <sup>2</sup> ) |  |                              | 2300   |       |       |        |        |         |         |         |         |         |         |
|   | Variable speed range                                  |  |                              | Auto measurement mode<br>0.01 - 700 (Stepless control)                                       |       |       |        |        |         |         |         |         |         |         |
|   |   |  |                              | Joystick and manual mode (Automatic measurement)<br>0 - 120 (Stepless control)               |       |       |        |        |         |         |         |         |         |         |
|   | Measuring speed (mm/sec)                              |  |                              | Joystick and manual mode (Automatic measurement)<br>0 - 5                                    |       |       |        |        |         |         |         |         |         |         |
| Accuracy guarantee environmental temperature conditions | Environmental temperature                             | Temperature condition A (°C)   | 18 - 22                      |  |       |       |        |        |         |         |         |         |         |         |
|   |   | Temperature condition C (°C)   | 16 - 26                      |  |       |       |        |        |         |         |         |         |         |         |
|   |   | Temperature condition E (°C)   | 15 - 30                      |  |       |       |        |        |         |         |         |         |         |         |
|   | Temperature changes                                   | Temperature condition A (°C/hour)  | 1.0                          |  |       |       |        |        |         |         |         |         |         |         |
|   |   | Temperature condition A (°C/day)   | 2.0                          |  |       |       |        |        |         |         |         |         |         |         |
|   |   | Temperature condition C (°C/hour)  | 1.0                          |  |       |       |        |        |         |         |         |         |         |         |
|   |   | Temperature condition C (°C/day)   | 2.0                          |  |       |       |        |        |         |         |         |         |         |         |
|   | Temperature gradient                                  | Temperature condition E (°C/hour)  | 2.0                          |  |       |       |        |        |         |         |         |         |         |         |
|   |   | Temperature condition E (°C/day)   | 5.0                          |  |       |       |        |        |         |         |         |         |         |         |
|   |   | Temperature condition A (°C/m)   | 1.0                          |  |       |       |        |        |         |         |         |         |         |         |
| Air supply  | Supply pressure / Working pressure (MPa)              |  |                              | 0.49 - 0.69 / 0.39   |       |       |        |        |         |         |         |         |         |         |
|   | Consumption (NL/min)                                  |  |                              | 55   |       |       |        |        | 85      |         |         |         |         |         |
| Power supply  | Voltage (V/%)   |  |                              | AC100/110/115/120/125/220/230/240 ±10<br>(adjusted in factory shipping) (grounding required) |       |       |        |        |         |         |         |         |         |         |
|   | Power consumption (W)                                 |  |                              | 1210   |       | 1210  |        |        | 1350    |         |         | 1500    |         |         |
| External dimensions and mass                            | External dimensions                                   | Width (mm)   | 1462                         |  | 1716  |       |        | 1866   |         |         | 1930    |         |         |         |
|   |   | Depth (mm)   | 1450                         | 1650   | 1550  | 1950  | 2450   | 1950   | 2150    | 2450    | 2050    | 2250    | 2550    |         |
|   |   | Height (mm)  | 2339                         |  | 2578  |       |        | 3015   |         |         | 3015    |         |         |         |
|   | Body mass (kg)  |  |                              | 1610   | 1800  | 2100  | 2550   | 3150   | 2850    | 3100    | 3450    | 3800    | 4100    | 4600    |
|   | Machine height at transport <sup>2</sup> (mm)         |  |                              | 1940   |       | 2080  |        |        | 2050    |         |         | 2050    |         |         |

\*1 The measuring accuracy is based on the following evaluation methods and use of standard stylus.

<Evaluation methods>

E<sub>0</sub>, MPE, E<sub>150</sub>, MPE and R<sub>0</sub>, MPL... JIS B 7440-2: 2013 (ISO 10360-2: 2009)

P<sub>FTU</sub>, MPE... JIS B7440-5: 2013 (ISO 10360-5: 2010)

MPE<sub>THP</sub>... JIS B7440-4: 2003 (ISO 10360-4: 2000)

<Standard stylus>

E<sub>0</sub>, MPE, E<sub>150</sub>, MPE, R<sub>0</sub>, MPL and P<sub>FTU</sub>, MPE... Tip diameter: Φ5, Length: 50 mm

MPE<sub>THP</sub>... Tip diameter: Φ3, Length: 50 mm

\*2 Be sure to check the height of passageways, and, in particular, the height of doors and other openings to be used when the machine is delivered. The height of openings needs to be specified each machine height at transport plus about 200 mm to allow for the dollies used to move the machines.

## External View

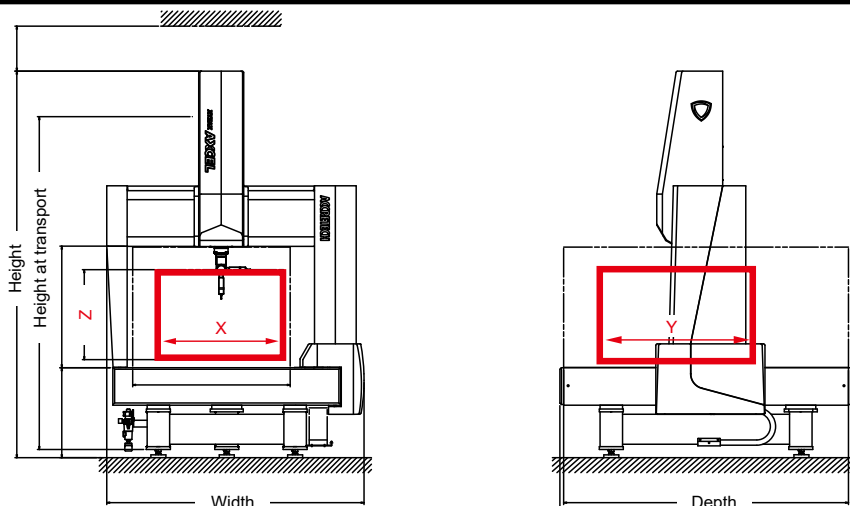



# XYZAX AXCEL RDS probe composition

| XYZAX AXCEL RDS  |          |          |
|--|----------|----------|
| 12/15/10   | 12/20/10 | 12/25/10 |
| 1200   |          |          |
| 1500   | 2000     | 2500     |
| 1000   |          |          |
| Linear scale   |          |          |
| 0.01   |          |          |
| 2.2 + 3L/1000  |          |          |
| 2.7 + 3L/1000  |          |          |
| 2.2 + 4L/1000  |          |          |
| 2.7 + 4L/1000  |          |          |
| 2.2 + 5L/1000  |          |          |
| 2.7 + 5L/1000  |          |          |
| 2.2  |          |          |
| 2.5  |          |          |
| 3.8<br>(T = 75 s)  |          |          |
| Air bearings   |          |          |
| Gabbro   |          |          |
| 1470   |          |          |
| 2500   | 3100     | 3600     |
| 630  |          |          |
| JIS Class 1  |          |          |
| M10 threaded hole  |          |          |
| 1200   |          |          |
| 1500   | 1000     |          |
| 2300   |          |          |
| Auto measurement mode<br>0.01 - 700 (Stepless control)                                       |          |          |
| Joystick and manual mode (Automatic measurement)<br>0 - 120 (Stepless control)               |          |          |
| Joystick and manual mode (Automatic measurement)<br>0 - 5                                    |          |          |
| 18 - 22  |          |          |
| 16 - 26  |          |          |
| 15 - 30  |          |          |
| 1.0  |          |          |
| 2.0  |          |          |
| 1.0  |          |          |
| 2.0  |          |          |
| 5.0  |          |          |
| 1.0  |          |          |
| 1.0  |          |          |
| 0.49 - 0.69 / 0.39   |          |          |
| 90   |          |          |
| AC100/110/115/120/125/220/230/240 ±10<br>(adjusted in factory shipping) (grounding required) |          |          |
| 1500   |          |          |
| 2180   |          |          |
| 2550   | 3150     | 3650     |
| 3415   |          |          |
| 5200   | 6300     | 7600     |
| 2250   |          |          |

